

B09

Dust Collector

B09 is a compact, quiet and efficient dust collector with multiple filter bags, ID fan, fan motor, auto shaker and electrical controls with timer. Dust filled air is filtered by wire cage mounted filter bags which undergo periodic shaking to remove dust cakes. Dust cakes are collected in removable bin.

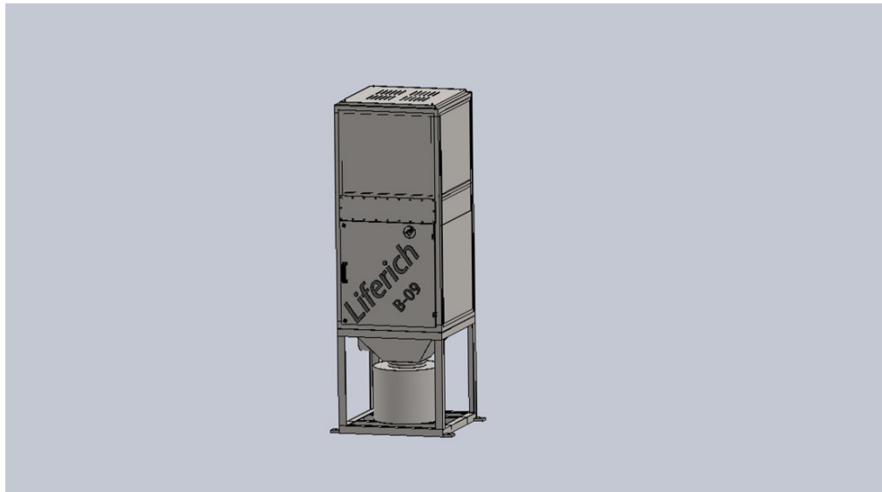

Machine Features

- Capacity – 900 cfm
- No. of Filter Bags – 09
- Air Inlet tube diameter – 150 mm
- Power – 2.4 kw
- No of Bins – 01
- Dimensions (LxWxH) in mm : 845 x1083 x 2222
- Gross Weight : 362 kg

